

FREE

# School News

Education + Communication = A Better Nation



Covering the Monrovia Unified School District

VOLUME 2, ISSUE 7

NOVEMBER / DECEMBER 2015

## SUPERINTENDENT



### Evaluating Test Results

Results for the Smarter Balanced Assessment Consortium (SBAC) test, which students in third through eighth and 11th grades took last spring, were released in September.

Dr. Katherine Thorossian

The new standards set higher expectations for students—and the new tests are designed to assess college and career readiness using the standards as a benchmark. For that reason, expectations for student achievement are higher than they used to be, and it is likely that fewer students will score at the higher achievement levels on the assessments.

Across the state, proficiency rates in both English language arts and math on the new test are lower for the students than on the last California Standards Test scores in 2013. This does not mean that our students are doing worse than in previous years; rather, the scores represent a new baseline, which provides a more accurate indicator for educators, students, and parents. Monrovia Unified School District teachers use a variety of methods to gauge student progress throughout the school year, including quizzes, tests, group projects, oral presentations, class participation, and homework. This test provides valuable additional data to consider as we refine our curriculum, monitor student progress, develop appropriate interventions, and update lesson plans to ensure that every child learns.

We are happy to report that, in every grade level and in both subjects, our students scored above the state average. This was not the case in 2013, as the graph below reflects. There is still much more work to do, and the educators of Monrovia Unified have already begun working to address notable gaps.

## 2015 Honorees

Jan, Mrs. Marlia, the Michael Jordan of Clifton, the True MVP, Our Rock, The Absolute Best are some of the ways staff members describe, in a few words, the amazing office manager at Clifton Middle School, Jan Marlia. Jan came to the Monrovia Unified School District in



Jan Marlia  
Classified Employee of the Year

1995 and served as an instructional aide at Bradoaks Elementary School. She was promoted to a clerical position in 1998 and continued to promote until 2011, when she was selected to be the officer manager at Clifton Middle School. Her staff made the following comments about her.

“She is efficient, effective, composed, kind, caring, has a great sense of humor, selfless, supportive, creative, positive, patient, a team player, a good listener, laid-back, and easygoing.”

“She makes all students feel welcome and is so helpful to all teachers.”

“She makes everyone around her better.”

Jan is a proud Monrovia, and we are so thrilled to be able to celebrate her contribution to our school and community.

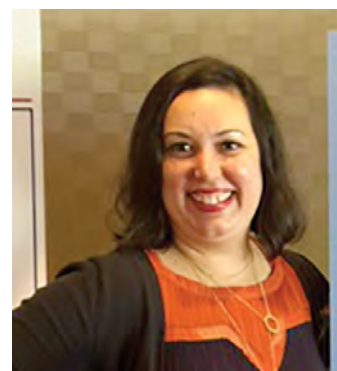

Yvonne Koskela  
Teacher of the Year

Santa Fe Middle School is proud to have among its ranks the 2015 Monrovia Unified School District Teacher of the Year, Ms. Yvonne Koskela. Yvonne first came to Santa Fe Middle School in 2002, where she began her tenure as a science teacher. Since that time, Yvonne has come to wear many hats, supporting Santa Fe in many different ways.

In the area of science, Yvonne has expanded beyond the classroom walls to lead the robotics program, as well as to develop partnerships for the Science Olympiad. Her robotics teams rank among the highest middle school teams in the state each year. She takes great pleasure in teaching her teams to grow beyond their wildest dreams — beating not only other middle schools, but both public and private high schools in Southern California.

Beyond the area of science, Yvonne has been integral in revamping the Latino Literacy project, which aids parents in navigating the complexities of our educational system and offers strategies through which to support their children in school. She has also been the lead in promoting the English-Language Advisory Committee and is an active member of the School Site Council.

We are proud of Yvonne for all that she has accomplished and are so fortunate to have someone of her caliber enriching the lives of students every day. Congratulations, Yvonne!

## Percent Proficient Charts Referenced in Superintendent’s Article

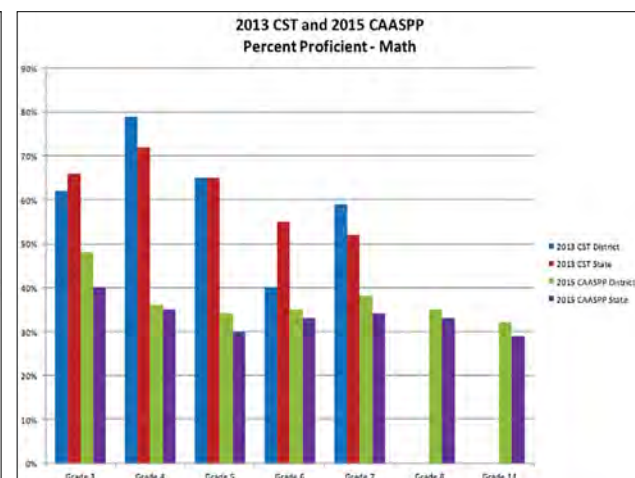
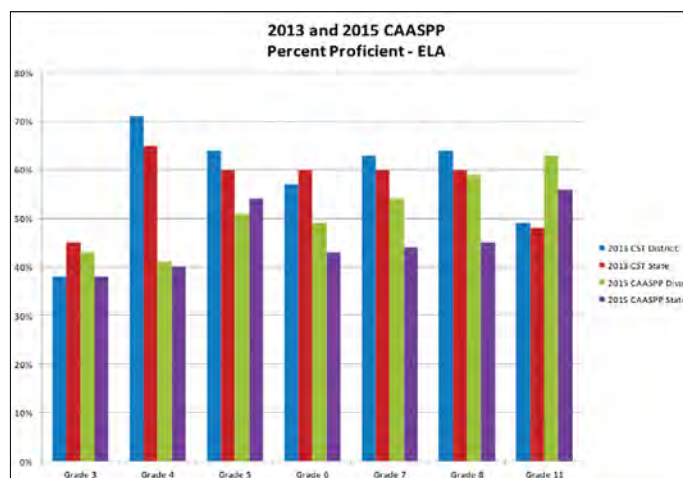



# The more they grow, the more you **SHARE.**

Their bright future is coming fast. Share more by investing with ScholarShare, California's 529 College Savings Plan. You'll take advantage of low fees, plus tax-free growth potential and withdrawals to be used at most colleges, universities and trade schools—and you can start with just \$25.

**Open a ScholarShare 529 College Savings Account for your child today.**



Consider the investment objectives, risks, charges and expenses before investing in the ScholarShare College Savings Plan. Visit [ScholarShare.com](http://ScholarShare.com) for a Plan Disclosure Booklet containing this and other information. Read it carefully. Investments in the Plan are neither insured nor guaranteed, and there is a risk of investment loss. TIAA-CREF Tuition Financing, Inc., Program Manager. The ScholarShare 529 Twitter and Facebook pages are managed by the State of California. The tax information contained herein is not intended to be used, and cannot be used, by any taxpayer for the purpose of avoiding tax penalties. Taxpayers should seek advice from an independent tax advisor based on their own particular circumstances. Non-qualified withdrawals may be subject to federal and state taxes and the additional federal 10% tax. Non-qualified withdrawals may also be subject to an additional 2.5% California tax on earnings.

C16908



**SCHOLARSHARE**

CALIFORNIA'S 529 COLLEGE SAVINGS PLAN

[scholarshare.com](http://scholarshare.com)  



# School News

Education + Communication = A Better Nation

www.schoolnewsrollcall.com

## Covering the MONROVIA UNIFIED SCHOOL DISTRICT

**FOUNDER/PUBLISHER:** Kay Coop  
562/493-3193 • kay@schoolnewsrollcall.com

**ADVERTISING SALES:**  
562/493-3193 • Fax: 562/430-8063

**CONTENT COORDINATOR:** Barbra Longiny

**GRAPHIC DESIGNER:** Meshel Negrete

**COPY EDITORS:**  
Lisa Brock, Kate Karp & Anna Zappia

**CONTRIBUTING CARTOONIST:**  
Netragrednik by Neta Madison

 @SchoolNewsRC

 SchoolNewsRollCall

 SchoolNewsRollCall

### SCHOOL NEWS ROLL CALL, LLC

P.O. Box 728, Seal Beach, CA 90740  
562/493-3193

www.schoolnewsrollcall.com

Copyright © 2006, School News Roll Call, LLC  
Reproduction in whole or in part without written permission is strictly prohibited unless otherwise stated. Opinions expressed by contributing writers and guest columnists are their views and not necessarily those of *School News Roll Call*. This publication is privately owned and the right is reserved to select and edit content. The school district does not endorse the advertisers in this publication.



**Kay Coop**  
Founder/Publisher



The Superintendent's message on the front page is very informative...so many changes in education including evaluating testing result and meeting expectations. Students have more academic choices than in years past, but the standards are high.

As I am driving it is shocking to me to see so many adults texting. Please set an example for your children—obey; the law and don't text and drive.

Our next issue is January 13, 2016. In the meantime, have a Happy Thanksgiving, Happy Holidays and Happy New Year!

## Board of Education



**Ed Gililand**  
President



**Rob Hammond**  
Vice President



**Bryan J. Wong**  
Clerk



**Terrence G. Williams**  
Member



**Alexandra K. Zucco**  
Member

## Your Monrovia REALTOR®



### GINA AMMON

YOUR MONROVIA REALTOR®

310.489.1021

gina.ammon@podley.com

242 W. Foothill Blvd.

Monrovia, CA 91016

CalBRE #01498679



*Gina loves helping families, one dream home at a time.*

## KANGEN WATER™

Water As Nature Intended

### Donald L. Outland

Molecular Hydration

562.305.6036

f:562.598.1815

doutland2@hotmail.com

patch.enagicweb.net

## WHY CHOOSE PRIMELENDING AS YOUR LENDER?

WE'RE THE MORTGAGE-ONLY EXPERT THAT TREATS YOU LIKE A NEIGHBOR, NOT A NUMBER.

### WE OFFER:

- A VARIETY OF HOME LOANS FOR A RANGE OF CREDIT SCORES
- STEP-BY-STEP PERSONALIZED GUIDANCE
- FAST UNDERWRITING AND LOAN CLOSINGS



**Diane Balsamo Gonzales**  
Senior Loan Originator

Direct 626-755-5764  
dbalsamo@primelending.com  
128 E Palm Ave, #100  
Monrovia, CA 91016  
NMLS: 482962

**PrimeLending**  
A PlainsCapital Company

All loans subject to credit approval. Rates and fees subject to change. Mortgage financing provided by PrimeLending, a PlainsCapital Company. Equal Housing Lender. © 2015 PrimeLending, a PlainsCapital Company. PrimeLending, a PlainsCapital Company (NMLS: 13649) is a wholly owned subsidiary of a state-chartered bank and is licensed by: Licensed by the Department of Business Oversight under the California Residential Mortgage Lending Act-lender lic no. 4130996. V070213.





# Bradoaks *Elementary*

930 East Lemon Ave., Monrovia, CA 91016 • 626/471-2100 • www.MonroviaSchools.net

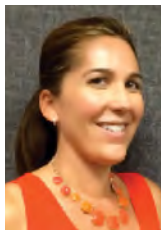

**Aimee Dyrek**  
Principal

## Pig o' My Heart!

The Bradoaks Bobcats continue to ROAR on as the 2015–16 school year is now in full swing! Respectful, On Task, Attitude in Check, and Responsible—our schoolwide expectations are a huge part of the Bradoaks culture. Our students are continuing to utilize their critical thinking and reasoning skills as they tackle the Common Core!

Teachers continue to use the Swun math curriculum as well as incorporate the Nancy Fetzer reading and writing strategies. Teachers have also been furthering their professional knowledge as teacher teams dive into the Next Generation Science Standards at UCLA's Center X.

Technology is abuzz at Bradoaks as we thoughtfully integrate web-based resources into lessons. In fact, our new mobile computer lab allows our students more time with technology while in their classrooms.

The Bradoaks PTA continues the proud tradition of service for students and staff while building a strong school community. PTA sponsored our First Hogs and Kisses fund-raiser in which teachers committed to kissing Penelope, the potbellied pig, for pledges that benefited students through the purchase of classroom materials. It was a great way to launch our schoolwide theme "Bobcats Are WILD about Learning!" ROAR on!



**Penelope with Principal Aimee Dyrek.**

# Canyon Oaks H.S./Mountain Park/ Monrovia Community Adult

930 Royal Oaks Dr., Monrovia, CA 91016 • 626/471-3000 • www.MonroviaSchools.net



**Flint Fertig**  
Principal

## National Finalist

Mountain Park School is proud to announce that senior, Heather Mercieca, is a national finalist in the teen division of NASA & the ASME Foundation's 3D Space Container Challenge.

She was interviewed by a panel of experts, including Astronaut Nicole Stott. Heather was challenged to put her engineering skills to work to create a space container that would meet current real needs that NASA faces. Heather's superior design was immediately recognized, making her one of three finalists in the competition.

The ECOnainer hosts a mini ecosystem which takes advantage of ant-plant mutualism: when ants and plants engage in a partnership that is beneficial to both parties. Based on this idea, the ECOnainer creates a secure environment for plant growth in space. The ants dig tunnels through the soil which aids in decomposition, the spread of nutrients, and soil aeration. Ants can even protect the plant from microbial pathogens.

Follow this link for more information: <http://www.futureengineers.org/#home>.

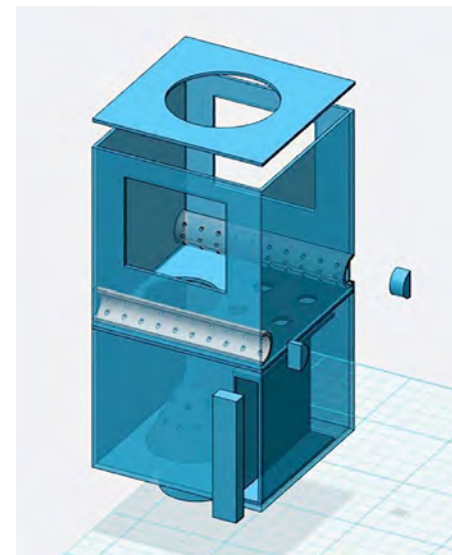

# Mayflower *Elementary*

210 North Mayflower Ave., Monrovia, CA 91016 • 626/471-2200 • www.MonroviaSchools.net



**Dr. Tamar Kataroyan**  
Principal

## Exciting Developments

At Mayflower Elementary School, we celebrate 365 days a year for all of the amazing student accomplishments that make us so proud.

I am delighted to share that our powerful MUSD and Mayflower Elementary PTA partnership yielded a \$20,000 "Let's Play" grant. What a gift for our children and community! Let's Play is a community partnership led by a local corporation and KaBOOM! It helps to get children and families playing nationwide. We received the top votes nationally, for a total of 7,993!

Along with community partners like the Boys and Girls Club of the Foothills, the AYSO, MYB, Boys Scouts, Girls Scouts, City of Monrovia, Assembly members, local businesses, neighbors, and the Monrovia Chamber of Commerce, we all recognize that play is essential to the welfare of every child.

Thank you to everyone who joined this effort to get connected and be involved in taking our dream to a reality, especially on our recent Community Build Day on September 26. Dream, Believe, and together we can Achieve!

We held our official ribbon-cutting ceremony on Monday, September 28. It included a new slide and swing set, with a total of 8 swings, two of which are accessible swings seats. There is also an accessible climbing dome designed for all children, and which enables more inclusive play.





## Canyon *Early Learning Center*

1000 South Canyon Blvd., Monrovia, CA 91016 • 626/471-2001 • www.MonroviaSchools.net



**Mariana Sanchez**  
Director

### Harvest of Opportunities

Fall is a wonderful time for exploration and discovery at Canyon Early Learning Center. We will discover the colors of fall through themes such as leaves, make-believe and pumpkins. The season wraps up with discussions about family, friends and gratitude. The children will have fun walking through and taking pictures in our pumpkin patch, made possible through donations from families and community members. If you would like to make a pumpkin donation, please call the school office.

Fall also brings some exciting opportunities for parents. The first is the Latino Family Literacy Project "I Am Ready/Lista!" program, which uses developmentally appropriate books to teach parents how to read with their children, pose questions, and support school-readiness skills. The second is the Positive Solutions for Families parent series from The Center on the Social and Emotional Foundations for Early Learning. The series covers topics such as "Making a Connection," "Making It Happen," "Why Do Children Do What They Do?," "Teach Me What to Do" and "Facing the Challenge to Promote Positive and Effective Parenting Behaviors." This educational series is designed to promote children's social and emotional development. We hope you join us for one or all of these presentations. Additional information is available on our website.

## Clifton *Middle School*

226 South Ivy Ave., Monrovia, CA 91016 • 626/471-2600 • www.MonroviaSchools.net



**Jennifer Jackson**  
Principal

### Cub Academy

Last spring, Clifton Middle School was named a 2014 Campaign for Business Education Excellence Honor Roll School in California due to increased student achievement over the past few years. As we continue this journey of increasing achievement for all students, Clifton's amazing teachers have created a new model to support both intervention and enrichment for students within the school day.

In addition to our normal elective offerings, the new Cub Academy allows students in need of extra academic support to have intervention courses without sacrificing the opportunity to have an elective and not conflicting with afterschool co-curricular opportunities. For those students who do not need the academic support, an additional enrichment period is offered. These offerings rotate every quarter and allow students to explore a variety of activities, including: Science, Technology, Engineering and Mathematics (STEM); athletics; debate; wood-chip carving; astronomy; introduction to leadership; engineering projects; electronics; drumline; conversational Japanese; dance; jigsaw puzzles; computer programming; animal care; chess; yearbook; cross-stitch; and music.

As the first quarter draws to a close, students have expressed enthusiasm about the new the Cub Academy and are looking forward to making course selections for second quarter. It has created a culture of excitement and motivation for all students at a very pivotal time in their adolescent development. We look forward to the continued development of this program as we work collaboratively with our teachers and foster partnerships with our parents and community to provide cutting-edge opportunities for our students.

## Monrovia *High School*

845 West Colorado Blvd., Monrovia, CA 91016 • 626/471-2800 • www.MonroviaSchools.net



**Kirk McGinnis**  
Principal

### Monrovia High School Students: On Their Way to College!

The spring of 2015 was an exciting time for many of MHS' students as they received their acceptance notices for the college that they would attend this fall. As an example, Bonnie Zucco is attending George Washington University, Josh Santiago is attending UC Berkeley, Austin Newton, Salutatorian, is attending UCLA, and Elizabeth Martinez is attending the Art Institute in Chicago. The journey for these for students and hundreds of others began with assistance from teachers, counselors and administrators at MHS.



The college admission session for 2015-16 has begun. This fall the sequence of events that lay the groundwork for college began on September 17th with over 80 representatives from four-year colleges, trade schools, and the military came to assist nearly 600 students and parents in making post-secondary selections. Counselors are busy meeting with seniors, one-on-one, to assist with their college and career plans, making sure that all of the elements of applications and planning are in order to create a seamless transition.

Some things that families can do to help their student(s) get ready during their junior year is to build a list of colleges and universities that are of interest to the student. Then, check the requirements in terms of grade point averages, SAT or ACT test thresholds. Plan school visits and attend college fairs to learn more about what each school has to offer. Most importantly, draw a timeline of key events and deadlines, such as application filing dates, to ensure all deadlines are met. Finally, plan early; you can never have too much time to start preparing for college.

## School News

*Education+Communication=A Better Nation*

Perfect for:  
Stay-at-home Moms/Dads  
Retirees...You!

## Join Our Sales Team!

*Work from Your Home  
28 Publications to Sell  
Choose the area you know best!*

- Name your own hours
- 25% Commission
- Sales experience helpful

Ask for Kay **562-493-3193**  
kay@schoolnewsrollcall.com • www.schoolnewsrollcall.com



## Monroe *Elementary*

402 West Colorado Blvd., Monrovia, CA 91016 • 626/471-2300 • www.MonroviaSchools.net



**Cynthia Lathrop**  
Principal

### Language Learners

Monroe Elementary School is excited about Foreign Language Academy, Monroe Elementary (FLAME), a Spanish dual-language immersion program, which is now in its sixth year of operation.



Learning a second language at an early age enriches and enhances a child's academic development. It also benefits children by promoting creative thinking and a greater sensitivity to languages and other cultures. Students who speak more than one language are better prepared to work in a global environment when they leave school. The goal of dual-language programs is for all students to become fluent and literate in two languages by the time they leave fifth grade.

Instruction is presented by the teacher primarily in Spanish in transitional kindergarten, kindergarten, and first grade. The amount of English is increased each year. By fifth grade, material presented in English accounts for 50 percent of instructional time.

School tours will begin on January 10, 2016. Parents who are interested in learning more about this exciting program are encouraged to attend one of the tours, which are held on Monday mornings. For more information, call the school office at (626) 471-2300.

## Santa Fe *Middle School*

148 West Duarte Rd., Monrovia, CA 91016 • 626/471-2700 • www.MonroviaSchools.net



**Dr. Caroline Sweeney**  
Principal

### Cultivating their Passions

It's "The Circle of Life" at Santa Fe Middle School! During the summer of 2015, we had 40 students, a host of parents, and one dedicated teacher (Mrs. Megan Forbes) turn our Santa Fe cafeteria into the "pride" lands by showcasing the Broadway musical *The Lion King*.

Through six weeks of intensive choreography, blocking, singing, and acting, our students were able to bring the show to life. Not only were they the actors, they were also the set builders, costume designers, makeup artists, and publicity generators for this event. Everything was done in-house, and everything was done by a Cougar!

Mrs. Megan Forbes, a history and English teacher at Santa Fe, was able to take a group of individuals and turn them into a real troupe. She has been so successful at this endeavor that there was enough extra interest to create a new drama class that is now a direct pathway to the Monrovia High arts program. We now have students expressing themselves in ways and methods that they did not have access to before!

Students can currently be found in our drama class or drama club, each refining their skills, voting on the next production, performing at assemblies, and integrating live performances into the regular classroom setting. At Santa Fe, we want all of our students to be able to cultivate their passions in a safe and nurturing environment. They have found that in drama. Hakunamatata Monrovia. And go, Cougars!



## Plymouth *Elementary*

1300 Boley St., Monrovia, CA 91016 • 626/471-2400 • www.MonroviaSchools.net



**Suzanne Heck**  
Principal

### A School-Wide Focus

Last year our Plymouth staff decided to focus on three things during the 2015–2016 school year.

The first goal is maximizing staff collaboration time. This goal is based upon our teachers working collaboratively to analyze student work. This analysis informs them about how their students are progressing towards mastering State Standards. With the assistance of a consultant, Charlotte Knox, our teachers will be given time to work together to plan lessons, units, and projects.

Our second area of focus will be on intervention. General education students whose progress towards mastery has stalled in reading will have more opportunities for after-school tutoring.

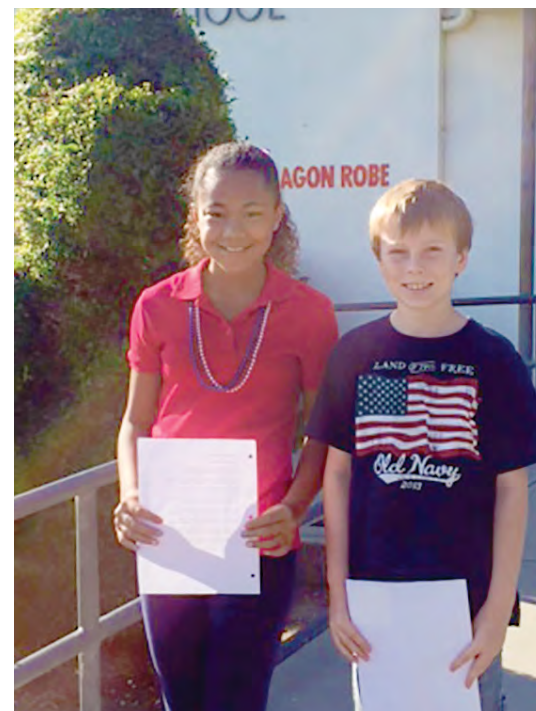

All students in grades one to five were given a reading assessment called DIBELS. This assessment tests student proficiency in reading. Those students who need more intervention based upon this assessment are now receiving extra tutoring. Students who are working at or above their grade level will be working with teachers in a small-group setting to help stretch and strengthen their skills and abilities.

In our third area, we will be providing a Positive Behavior Intervention and Support (PBIS) system. This means that students are not only aware of school rules and expectations, but also that the appropriate behaviors are reinforced.

The students in grades one to five recently watched a rules video made by our Plymouth staff. We have four rules at Plymouth, and all students are taught to follow them: walk; follow directions; keep your hands, feet, and objects to yourself; and be a friend, not a bully.

We believe that if we achieve each of these goals, our students will then achieve at the very highest levels!

## Wild Rose *Elementary*

232 Jasmine Ave., Monrovia, CA 91016 • 626/471-2500 • www.MonroviaSchools.net



**Stacy Ayers**  
Principal

### Energy Savings

Wild Rose Elementary School has become a PowerSave School and won first place in the school district last year for saving the most energy. Students participated in an afterschool club called the PowerSavers. Through the PowerSave Schools program, students were empowered to grow as leaders, apply academic knowledge to solve the real-world challenge of decreasing utility bills, and move their school and community toward a greener future with energy-efficient practices and measurable energy savings.

Wild Rose students were able to save over \$5,000 in energy costs last year. This entire savings was awarded to the school, and the PowerSave students voted to open up a second computer lab. This lab is fully equipped with a class set of mini computers.

Fifth-grade teacher Mrs. Jennifer Tubbs and head custodian Mr. Ray Alarcon partnered to work with club members. Together they taught lessons that had both rigor and relevance, allowing students to choose a path for their school. Students using our new computer lab already know that they chose well.

## Love Bug



Kate Karp

Are you a Beluga Grad? If Raffi was part of your childhood, you are. You dug into the meaning of “Baby Beluga” and had a great time singing “Down by the Bay.” And if you’re not one, here’s your chance to get a midlife diploma and mentor the children in your life.

Raffi Cavoukian, known by his first name, is bridging the near generation gap he created by not issuing a children’s CD in the last 12 years. *Love Bug* honors children and the world they live in; the collection is an extension of Raffi’s social-change movement, Child Honoring, as well as his desire to create environmental awareness and action as a team of humans. Worldly wise and socially and environmentally conscious, *Love Bug* pays lip service to causes only through what comes out between Raffi’s own lips.

All songs are meaningful and tuneful; they’re instructive for children and therapeutic for adults. “Mama Loves It” sings about teamwork beginning in the home. The instrumental “Pete’s Banjo” honors Pete Seeger, one of Raffi’s social inspirations. “Seeing the Heart,” like a Zen parable, is interpretable through intuition only, and “Water in the Well”—well, surely a teachable moment for our drought-parched state.

And “Turn This World Around” brings it all together. Raffi’s music is gentle and at the same time serious about the planet, both in leaving it for children and for children doing their part to preserve it. They, too, will be adults someday.

Discover Raffi’s Child Honoring philosophy at [www.raffinews.com/](http://www.raffinews.com/).

Kate Karp is an editor for *School News Roll Call* and a freelance writer and editor.



## Letters of Recommendation



Susan D. Marshall

Things you can do to tip the scale.

When it comes to getting financial aid, scholarships, merit money you will receive some of your best offers from the more selective colleges. That being said, they also have a more rigorous application process. Getting letters of recommendation is part of the process.

Select teachers who know you over a dignitary that may not. Most likely, you will receive a stronger letter of recommendation that stands out from the rest.

### Help Teachers and Counselors Help You

Make sure you arm your teachers/counselor with transcripts, a bio or brag sheet about yourself. Attach a project or some outstanding work that you did, possibly, in their class.

Make sure you are prepared in how you handle the situation.

Let them know that you don’t expect to see the letter. You need to give them the various forms they will need and envelopes already addressed to each of the schools where they are to send the letters.

You then want to make sure to follow up with thank you notes of appreciation. Teachers are not required to write letters for you. Counselors are. Both are more than worthy of the extra gratitude for their efforts.

You will shine all the more for the person you are.

Susan both educator and advisor specializes in college planning. She helps families save for and pay for college. If you have questions you would like answered in a future article contact her at [Susan@College4Less.com](mailto:Susan@College4Less.com) or on her Web site at [www.college4less.com](http://www.college4less.com)

# Bicycle Parts—Word Search Contest

**Rules!** One word in the list is NOT in the word search.  
When you have completed the word search, one word will be left and that word you email to: [Kay@schoolnewsrollcall.com](mailto:Kay@schoolnewsrollcall.com) (Please put Monrovia in the subject line)

Entries must be received by December 15, 2015.  
From the correct entries one name will be drawn to win a \$20 gift certificate redeemable at Barnes & Noble.

- |             |            |           |
|-------------|------------|-----------|
| BASKET      | FRAME      | LIGHT     |
| BRAKES      | GLOVES     | PEDALS    |
| CHAIN       | GOOSENECK  | REFLECTOR |
| CHAIN GUARD | GRIPS      | SEAT      |
| CRANK       | HANDLEBARS | SPOKES    |
| FENDERS     | HELMET     | TIRES     |
| FORK        | KICKSTAND  | WHEELS    |

**Congratulations to Travis Morrison  
Winner of the September Word Search Contest!**

H	A	N	D	L	E	B	A	R	S	K	M	X	S	A
C	M	P	S	D	N	A	T	S	K	C	I	K	P	H
H	K	V	E	T	Y	R	E	F	L	E	C	T	O	R
A	A	N	W	D	E	K	R	E	V	N	A	F	K	R
I	I	Y	A	H	A	M	B	N	R	E	I	L	E	T
N	N	T	Z	R	E	L	L	D	S	S	G	A	S	Y
G	F	R	B	T	C	E	S	E	V	O	L	G	H	T
U	S	L	M	G	T	M	L	R	H	O	C	G	Y	C
A	E	K	P	C	W	A	I	S	G	G	I	G	G	H
R	J	K	S	P	I	R	G	D	N	C	N	F	S	X
D	X	R	K	R	O	F	H	A	J	P	W	Z	L	V
L	P	W	S	E	R	I	T	B	R	R	R	W	K	Y



# Sierra

**Family of Dealerships**



**SierraAuto.com**

Proud sponsors of the The Pasadena Symphony & The Pasadena POPS

**A tradition of integrity and honesty**

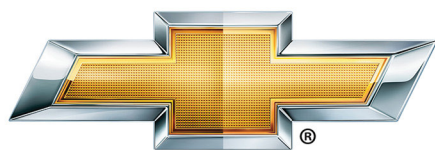

**CHEVROLET**

Sales/Service (626) 256-7600  
SierraChevy.com



**MAZDA**

Sales/Service (626) 303-0077  
SierraMazda.com



**SUBARU**

Sales/Service (626) 739-2222  
SierraSubaru.com



**ACURA**

Sales/Service (626) 284-8533  
SierraAcura.com



**CHRYSLER**

Sales/Service (626) 739-5400  
SierraChryslerDodgeJeepRam.com



Sales/Service (626) 739-5400  
SierraChryslerDodgeJeepRam.com



**HONDA**

Sales/Service (626) 739-2200  
SierraHonda.com

**Jeep**

Sales/Service (626) 739-5400  
SierraChryslerDodgeJeepRam.com

**San Gabriel Valley's Premier Dealership Group**